



VacuEasylift®

TAWI

The economic solution to an ergonomic problem

VacuEasylift is a manual vacuum lifting device that handles almost any type of load. The extremely smooth and quick operation is accomplished by using the same handle to lift, lower and release the load and by using the vacuum to hold and lift the load.

VacuEasylift is a world-leading, original Swedish product, patented in most countries of use. Based on a unique concept, VacuEasylift has been developed into a versatile system for simpler, safer and more effective lifting.



1. A typical installation for objects on which the suction foot must be placed on a curved area. This type of roll-handling is common in industries for the interior decoration i.e. carpets, wallpaper. Most often a two-man job before VacuEasylift is installed.



2. Retailers of alcoholic beverages use the VacuEasylift to handle boxes, crates and kegs. These units are equipped with a specially designed handle and are delivered with lightweight, lowbuilt aluminium jib cranes and crane systems.



3. Recycling of TV sets and other electronic devices. A rapidly growing area of application with VacuEasylift.



4. A VacuEasylift that lifts drums/tins/buckets is a popular installation in the pharmaceutical/chemical industries. We deliver suction feet for handling one or more tins at a time.



5. A VacuEasylift with a special tool attached for handling crates. This particular unit is equipped with a fast coupling to allow fast changes between the crate tool and another suction foot for boxes.



6



7

6-7. The finger tip controlled VM80 with a maximum capacity of 20 kg is suitable in the food processing and electronic component industries. Demands of extremely light handy tools for all types of production lines resulted in two versions of the VM80 to the left.

(Standard handle to the right)

VacuEasylift: lifting equipment that holds and moves the load with a speed of almost 1 m/s!

Light as air in all conceivable working conditions

Industry, engineering shops, warehouses, distribution terminals, VacuEasylift makes lifting easy in all conceivable working conditions.

VacuEasylift makes lifting safer, both for operators and for the products being handled.

Once VacuEasylift is installed you will no longer need to hire weightlifter staff to lift and move things.



1. VacuEasylift relieves strained shoulders and backs in the heart of building and landscaping materials industry.



2. Large and very thin steel plates are moved through this filmcoating machine.

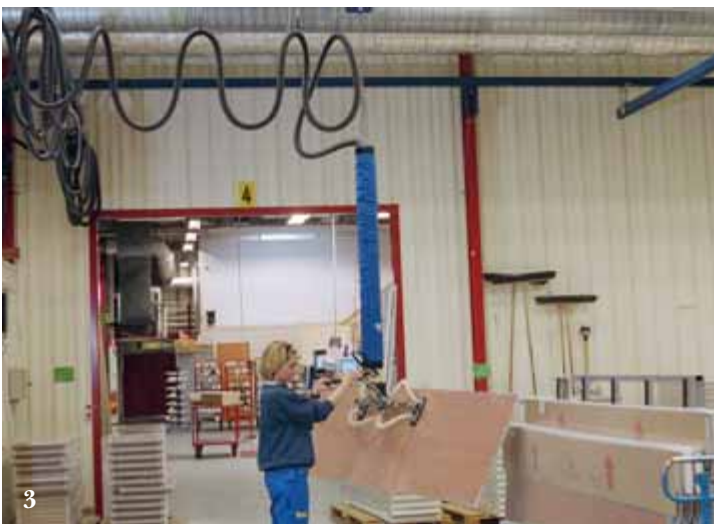

3



3-4. This system covers an area of in all 5 working stations. An angle adapter with handle is used to turn the suction foot 90 degrees and lift the panels from vertical to horizontal position.

Now all your employees can handle heavy and awkward objects.



1-2. The suction feet used to lift panels and boards vary in design due to variations in size, weight and density of material. In some cases two suction feet on a wide yoke is sufficient. This also applies to all types of window handling.



3. Low headroom and more or less no operating space? The VacuEasylift transformed the task of moving 60 kg panels to a punching machine into a one-man job.



4. The lumber industry depends on VacuEasylift to lift and move awkwardly large and heavy parts of primary produce. This beautiful piece of wood weighs 250 kg!



Best capacity and quality

The vacuum pump is the heart of the VacuEasylift, creating vacuum to operate the system. The high efficiency and low weight of these vacuum pumps ensures best capacity and quality. All components are tested prior to delivery.

Fast payback time

An investment in VacuEasylift pays for itself quickly. The system is easy to install and adjust to suit the requirements of most industries and loads. VacuEasylift gives you an optimum combination of efficiency, ergonomics and economy unmatched by any other lifting system.



1–2. An angle adapter with handle solves the problem of picking up a vertically positioned object and moving it into a horizontal position.



4. The optional remote control has quickly become a frequent request allowing the operator to control the vacuum pump without having to leave the operating area. Available with all units.

3. The operator uses VacuEasylift to move these 25 kg boxes from a scale and onto a pallet. The protective blue cover on the lift tube is optional.



1. The same suction foot can be used to handle the empty pallets and the boxes that were initially on the pallet.



2. A well known object, the flat, heavy box, handled with VM160 with lift tube adapted to give maximum lifting height in a low headroom operating area.

Lifting with air

VacuEasylift uses vacuum for both lifting and holding loads in place.

The air is channelled through a filter and an air tube to a lift tube fitted with a suction foot.

The vacuum inside the lift tube is regulated with a control handle. When the partial vacuum rises the lift tube retracts and lifts the load. When the partial vacuum sinks the tube stretches, and lowers the load.

VacuEasylift is a thoroughly proven system meeting the highest standards of functionality and safety. The suction foot holds the load securely in place until it has reached the floor. Loss of power does not cause problems. If there is a blackout, a safety valve shuts down and the load is lowered to the floor gently and under complete control.



1-2. Manual bag handling is extremely heavy and has therefore become one of the top ten most popular applications with VacuEasylift. The VM160 handles bags up to 60 kg which covers practically all bags handled in food and chemical industries.



4. All VacuEasylifts are available in stainless steel configuration, suitable for cleanroom applications and corrosive environments.

3. Our suction feet are designed to handle all types of bags. A rubber skirt is attached for porous materials such as paper bags. Shrink wrapped, vacuum packed, there is always a VacuEasylift solution available.

Jib cranes in aluminium up to 125 kg

For smooth and light manoeuvring of the unit we manufacture and distribute Lyftman jib cranes and crane systems in aluminium. The arm carrying the lift tube is available in different lengths, 2–6 m.

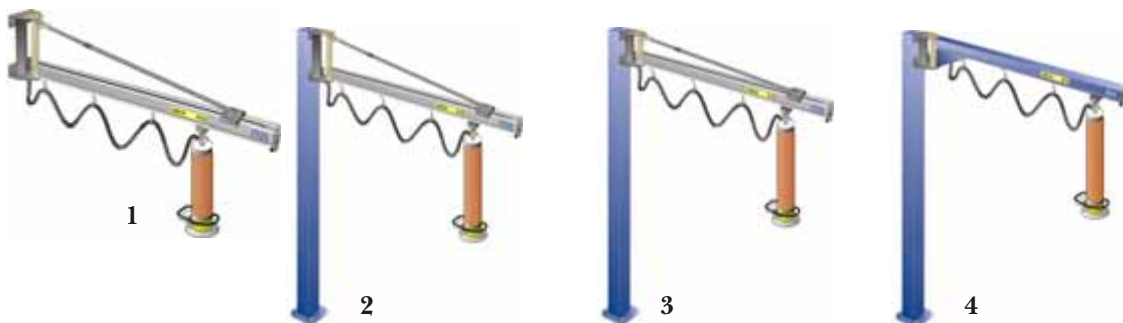

1. Jib arm, wall mounted. Max capacity 125 kg. Radius of action 180 degrees.

2. Jib arm, mounted on column. Max capacity 125 kg. Radius of action 240 degrees. Arm bracket measures 575/860 mm. Standard column height 3610/3840 mm.

3. Low built jib arm, mounted on column. Max capacity 40 kg. Radius of action 240 degrees. Arm bracket measures 300 mm. Standard column height 3000 mm. Also available as wall mounted jib cranes.

4. Inverted jib arm, mounted on column. For extremely low headroom. Max capacity 80 kg. Standard column height 3130 mm. Arm profile in steel. Also available as wall mounted jib cranes.

Crane systems up to 1500 kg

Lyftman crane systems can be suspended from the ceiling construction or a freestanding support structure. Lowbuilt systems are available for areas with ceiling heights below standard dimensions.



5. No need to build a complete system if the operating area planned to be served by the VacuEasylift is in fact a straight line. The Mono-rail is the perfect choice when there is no question regarding area of action.



7. A winning combination: Lyftman steel profiles in gantry with Lyftman aluminium profiles in crane bridge (up to 125 kg).

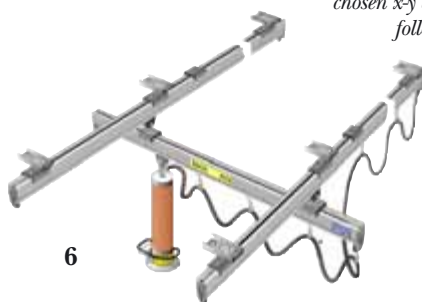

6. The crane system covers a chosen x-y area. The crane bridge follows the operator movements smoothly and keeps the VacuEasylift directly above the operator at all times.

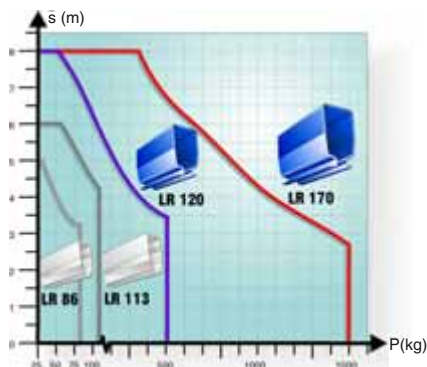

8. Easy to find the system you are looking for: S=Maximum possible distance between suspension points. P=SWL (Safe Working Load).

VacuEasylift in figures

Model	VM80	VM100/120/140		VM160/180		VM200/230		VM250	VM2160/2180		VM300
Lifting cap. kg	20	30/40/50	30/40/50	60/80	60/80	100/120	100/120	180	120	160	270
Length of lift tube mm	2000	2500	4000	2500	4000	2500	4000	2500	2500	4000	2500
Ø mm	80	100/120/140	100/120/140	160/180	160/180	200/230	200/230	250	2 x 160	2 x 180	300
L max mm	2240	2670	4170	2690	4190	2690	4190	2690	2630	4130	2690
L min mm	740	870	1570	890	1590	990	1790	1190	830	1530	1190
Lifting height mm	1500	1800	2600	1800	2600	1700	2400	1500	1800	2600	1500
Extended, flexible handle	Not available	Flexed extensions up to 800+800 mm standard.		Flexed extensions up to 800+800 mm standard.		Flexed extensions up to 800+800 mm standard.		Not available	Available on request		Not available

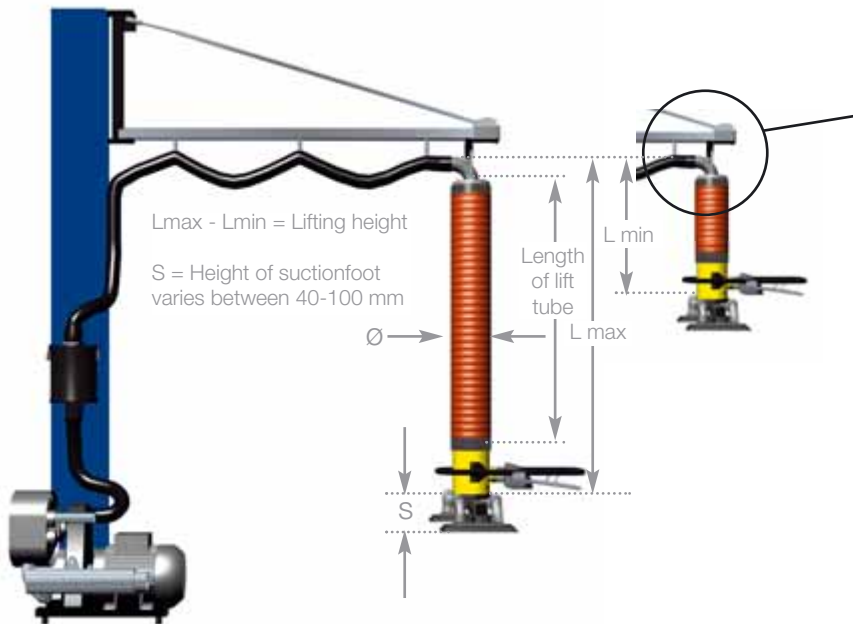

Lowbuilt swivel rotates the lifttube through 360 degrees with any load.

Motor in 2-stage gas ring vacuum pump. Can be located remotely without VacuEasylift losing efficiency. Designed for years of troublefree service. Explosionproof motor available.

Lift tube in tough neoprene, internally reinforced. Protective cover available.

Filters available in standard or heavy duty sizes. Stainless steel available for cleanroom facilities.

Vacuum pumps

Our vacuum pumps are high-efficiency, long-life machines with low electric consumption. Technical description, see below:



Pump unit	Power		Depression (mbars)	Weight (kg)	Tube model	Dimensions l x w x h (mm)
	@ 50 Hz (kW)	@ 60 Hz (kW)				
SA 200/2	1,1	1,3	720	49	VM 80	500x380x420
SA 320/2	2,2	2,55	550	34	VM 100 - 160	535x335x450
SA 350/2	3,0	3,45	630	41	VM 160 - 2180	630x335x450
SA 450/2	5,5	6,6	650	67	VM 160 - 2180	700x420x520

2. The vacuum pump mounted on a platform on the wall (art nr 1R-32526, also fits Lyftman columns). Silencing hood (art nr 66000) available for SA320/2, SA350/2.

VM80



85510 85x200 mm
(3.5"x7.9")



85520 Dia 145 mm
(5"3/4)



85530 Dia 130 mm (5")

VM100 VM120



30200* Dia 200 mm
(7.9")



30210 Dia 190 mm
(7.5")



30300* 165x270 mm
(6.5x10.6") Sacks



30305 165x270 mm
(6.5x10.6") Sacks, st. steel



30320 290x190 mm
(11.5x7.7") Sacks



30600* 2x85x200 mm
(2x3.5x7.9") Boxes etc



30650* 2x85x200 mm
(2x3.5x7.9") Boxes, panels



30700 100x250 mm
(3.9x9.8")



30710* 140x205 mm
(5.5x8")



30715 140x205 mm
(5.5x8") St. steel

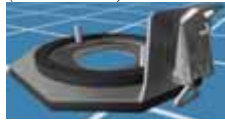

30250* Fast coupling,
upper



30260* Fast coupling,
lower

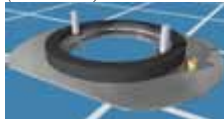

30270* Adapter plate
VM100/120



30350* Bottom swivel
360 degrees



30360*
Adapter plate 90 degrees



30460



30800 Angle adapter 90
degrees



30811 Handle for angle
adapter

VM140

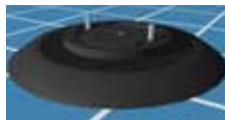

40230* Dia 270 mm
(10.6")



40650* 2x100x250 mm
(2x3.9x9.8")



40700 120x320 mm
(4.7x12.6")

VM160 VM180



10200 Dia 270 mm
(10.6") Tins, cans, drums



10230 Dia 270 mm
(10.6")



10300* 180x370 mm
(7x14.6") Sacks



10320 380x230 mm
(15x9") Sacks

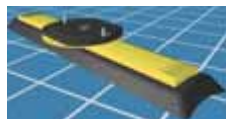

10400 125x580 mm
(4.8x22.5") Rolls etc



10500 125x580 mm
(4.8x22.5")



10600*
Panels 2x120x320 mm
yoke 400 mm
(2x4.7x12.6" yoke 15.7")
10610* Yoke 800 mm
(31.5")
10620* Yoke 1200 mm
(47.2")

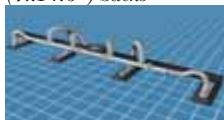

10630*
4x120x320 mm yoke
1800 mm (4x4.7x12.6"
yoke 70.8")



10650*
2x dia200 mm yoke
400 mm (2x dia7.9"
yoke15.7")
10670*
Yoke 600 mm (23.6")
10680*
Yoke 800 mm (31.5")



10700* 200x320 mm
(7.9x12.6")

10710* 200x290 mm
(7.9x11.4")



10705 200x320 mm
(7.9x12.6") St. steel



10850 200x330 mm
(7.9x13") Side lifter

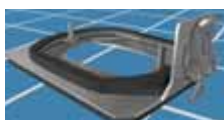

10250*
Fast coupling, upper

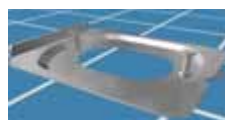

10260*
Fast coupling, lower



10350*
Bottom swivel 360 degrees

Many more suction feet and accessories
available on request.

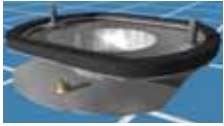

10360
Adapter plate 90 degrees

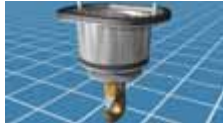

10440

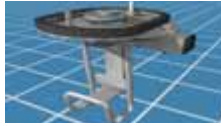

10450

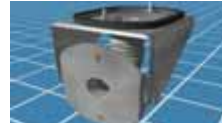

10810
Angle adapter 90 degrees

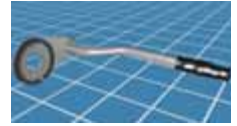

10811
Handle for angle adapter

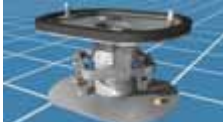

10820 Universal joint

VM200



20320 380x230 mm
(15x9") Sacks



20600*, Boxes, panels 2x140x
380mm yoke 500 mm (2x5.5x15"
yoke20") 20650 2x140x380mm
yoke 1200 mm (2x5.5x15" yoke47")



20300* 460x205 mm
(18x8") Sacks



21200 Dia 320 mm
(12.6") Drums etc



20350 *
Bottom swivel 360
degrees

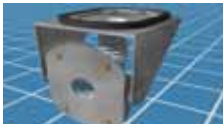

20810
Angle adapter 90 degrees

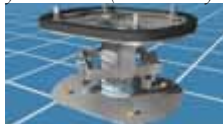

20820 Universal joint

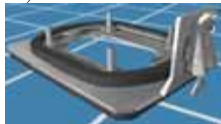

21250*
Fast coupling, upper

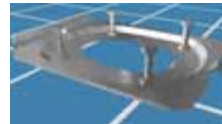

21260*
Fast coupling, lower

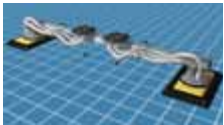

41360 2x200x330 mm
Panels. Yoke 740-1300 mm
(2x7.9x13"
yoke 29.1-51.2")

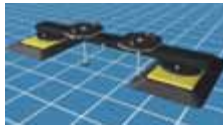

41370 2x200x330 mm
Panels. Yoke 765 mm
(2x7.9x13" yoke 30")

← VM2160/2180

Other accessories, examples

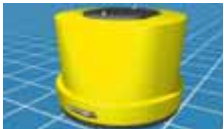

0102 Gas bottles etc

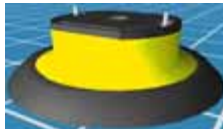

0114

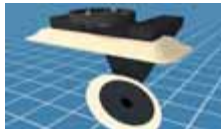

0116 TV:s etc



0250



0285

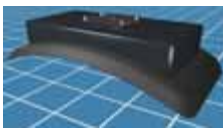

0296



0420



0450



0454 Panels

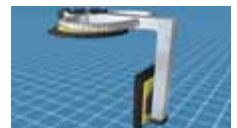

0471

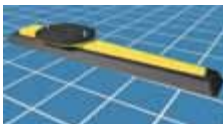

0540



0581

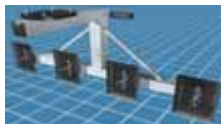

0603



0622



0670



Tube

THAT IS NOT ALL....

Our suction feet gaskets are made out of natural rubber and designed to fit every application perfectly. TAWI also manufactures gaskets for cleanroom areas. Suction feet for VM230/250/300 on request.

www.TAWI.com

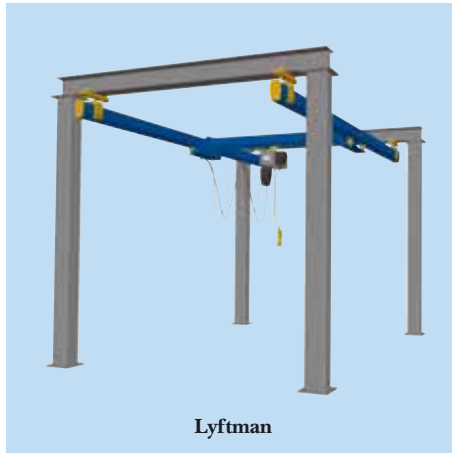

TAWI

TAWI AB
Transportgatan 1
Box 10205
SE-434 23 KUNGSBACKA
SWEDEN
Tel +46 300 185 00
Fax +46 300 189 90

Bergtorpsvägen 43A
SE-183 64 TÄBY
SWEDEN
Tel +46 8 446 48 50
Fax +46 8 446 48 55

info@tawi.se
www.tawi.com